

FITOK

COMPANY OVERVIEW

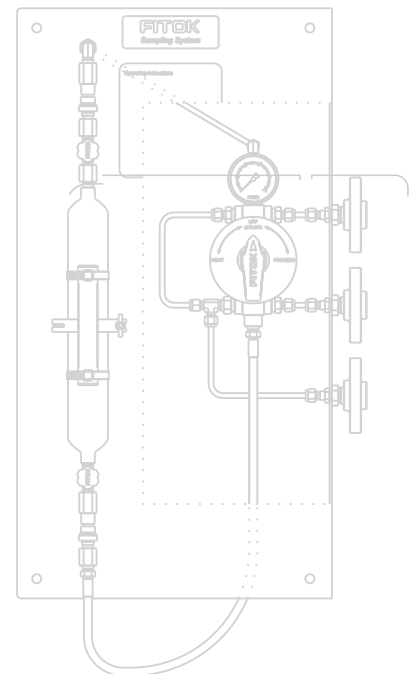

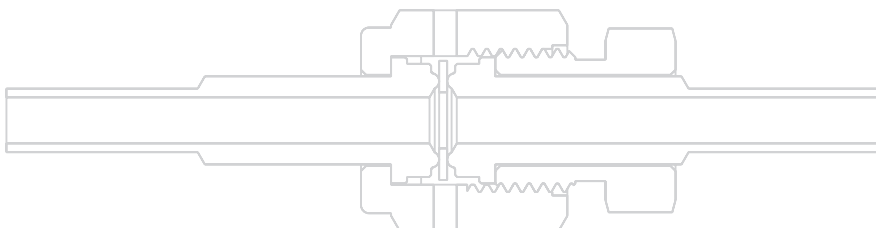
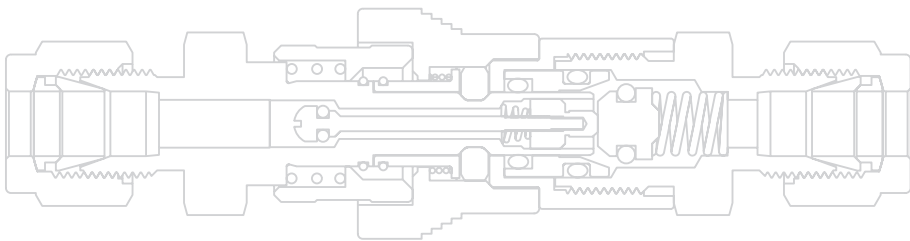

Germany (Headquarters)
R&D Center, Factory



The USA
Global Sales and Service Center

Manufacturing & Inspection Facilities



Supermatic Lathe

ABOUT FITOK

Founded in 1998, FITOK Group has been an industry-leading developer and manufacturer of superior quality instrumentation valves and fittings, having our R&D centers, manufacturing facilities, warehousing and service locations in Offenbach Germany, Texas USA, Shenzhen and Suzhou China, Dubai UAE and Alberta Canada.

We have the capability to manufacture and supply 5 different product categories, including:

- General Instrumentation Valves and Fittings
- Medium & High Pressure Valves and Fittings
- High Purity & Ultra High Purity Products
- Sampling Systems
- Tubing

Our mission is to provide the best quality products and the most professional services to our customers. The performance of our products is guaranteed during the whole manufacturing cycle from our employment of customized materials which should be controlled more strictly than just according to ASTM requirements to our implementation of production and testing exceeding the industry standards.

Since our inception, FITOK has been applying sound quality control standards in all activities. FITOK is an ISO 9001:2015 certified company and our products have been certified by different industry authorities and third-party inspection institutions in different countries to have obtained a variety of certificates, among which there are the TA-Luft, ABS, ASTM F1387, ISO15848, TPED, E-Mark, CRN, DVGW, PED, API and DOT certificates.

Benefiting from our global facilities, we are able to optimize the most cost-effective resources worldwide. Paired with flexible manufacturing systems, we deliver a wide range of the best quality products within a competitive lead time and the most professional services to our customers in an array of applications and industries.



Machining Center



Class 100 Cleanroom



Profile & Roughness Measuring Instrument



Coordinate Measuring Machine

CERTIFICATES



FITOK Germany ISO 9001



FITOK China ISO 9001

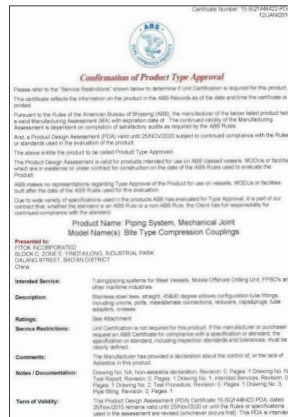

ABS

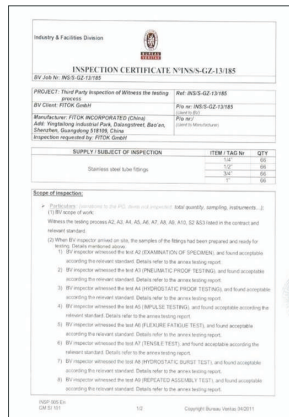

ASTM F1387



TA-Luft



DVGW

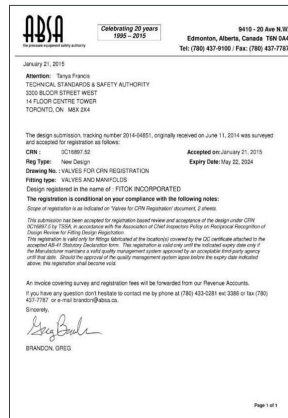

CRN



EAC

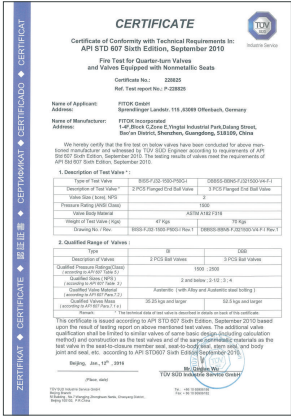

API 607



ATEX



TPED

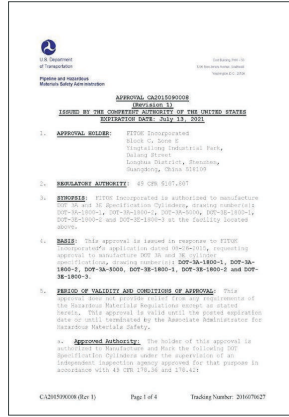

DOT

6 Series Tube Fittings



6 Series Pipe Fittings



37° Flared Tube Fittings



6 Series Weld Fittings



VL Series Vacuum Tube Fittings



VA Series Vacuum Adapter Fittings



Grease Fittings and Bleed Fittings



Fusible Fittings



Calibration Fittings and Hoses



Quick-connects

◎ **QC Series**

Instrumentation quick-connects



◎ **QV Series**

High flow quick-connects with valve



◎ **QF Series**

Full-flow quick-connects



◎ **QM Series**

Miniature quick-connects



◎ **QTM Series**

PTFE-sealed quick-connects



◎ **QCA Series**

High flow quick-connects with safety quick release



Hoses and Connectors

◎ **MH and MM Series**

Metal convoluted hoses



◎ **PS Series**

PTFE-lined, stainless steel braided hoses



◎ **MP Series**

Multipurpose push-on hoses



◎ **TH Series**

Thermoplastic hoses



◎ **HC Series**

Hose connectors and sleeves



Ball Valves

© **BF and BFH Series**

Trunnion ball valves, temperature as low as -40°F



© **BO Series**

One-piece instrumentation ball valves, no dead zone



© **BG Series**

3-piece ball valves, pressure up to 1,000 psig



© **BP Series**

Cold drawn bar ball valves, pressure up to 10,000 psig



© **BH Series**

3-piece ball valves, pressure up to 3,000 psig



© **BR Series**

Hex bar stock ball valves

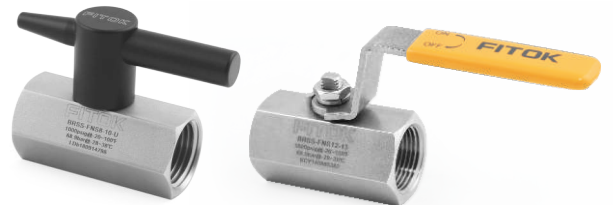

© **BV Series**

High performance ball valves, pressure up to 6,000 psig, working temperature: -65 °F to 450 °F



Automatic Control Ball Valves

© **BF, BFH, BH, BO, BP and BV Series**

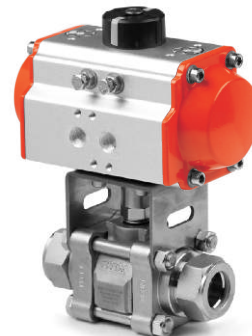

Needle Valves

© **NB Series**
Screwed bonnet needle valves



© **ND and NDH Series**
Nonrotating-stem needle valves



© **NF and NFH Series**
Forged-body needle valves



© **NG and NGH Series**
Integral bonnet needle valves



© **NT Series**
Toggle valves and pneumatic needle valves



© **NR and NRG Series**
Rising plug valves



© **NY Series**
Outside screw and yoke (OS&Y) needle valves



© **NU and NUH Series**
Union bonnet needle valves



Check Valves

Fixed cracking pressure (CV, CH, CO and CW series)

© CV Series



© CH Series

Pressure up to 6,000 psig



© CO Series

One piece body



© CW Series

All-welded design



Adjustable cracking pressure (CA and COA series)

© CA Series



© COA Series

One piece body



All-metal construction

© CL Series



Bellows-sealed Valves

© SW and SU Series



Metering Valves

© MS, MV, ML and MH Series



Plug Valves

© PV Series



Proportional Relief Valves

© RV, RL and RM Series



General Instrumentation

Purge Valves

© RP Series



Bleed Valves

© RB Series



Excess Flow Valves

© EV Series



Filters

© FT Series



© FB Series



© FI Series



© FW Series



Gauge Valves and Instrumentation Manifolds

Gauge Valves

© GV, GVH and GR Series



2-valve Manifolds

© 2D, 2R, 2DH and 2RH Series

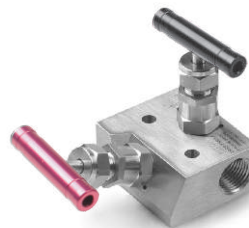

3-valve Manifolds

© 3D, 3R, 3DH and 3RH Series

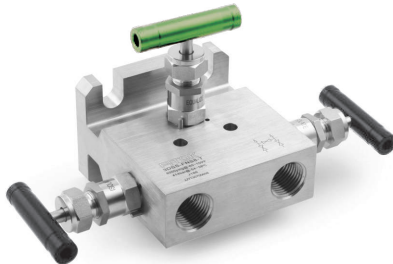

5-valve Manifolds

© 5D, 5R, 5DH and 5RH Series

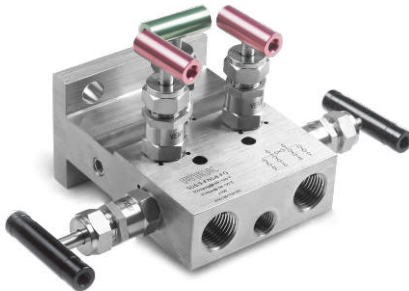

Block and Bleed Valves

© BB, DB, SB and DBB Series

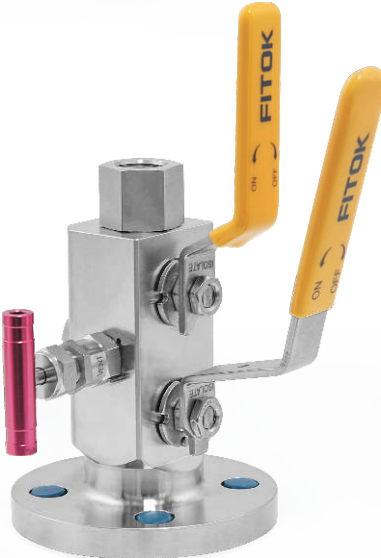
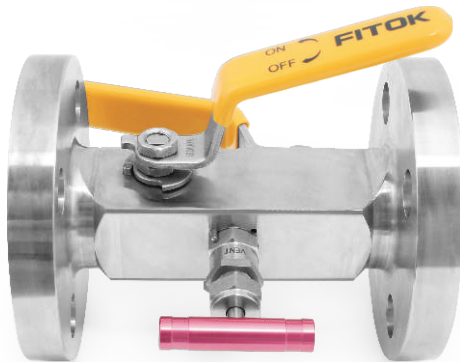
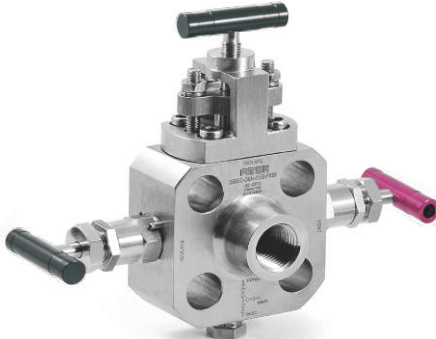

Two-piece Fire Safe Ball Valves

© BI Series

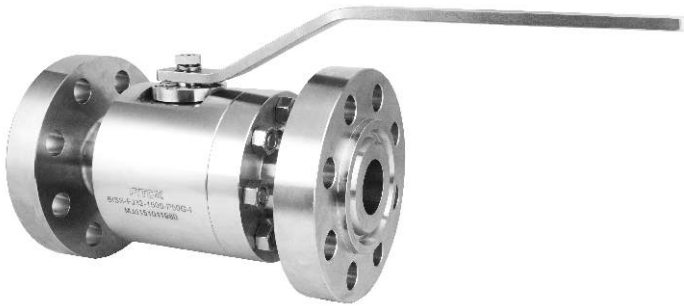

Air Headers and Distribution Manifolds

© AH and CM Series



Sample Cylinders



Condensate Pots and Vessels

© CP Series

© SV Series



Pressure Gauges

© GA, GB and GC Series



Stainless Steel Seamless Tubing



Tools and Accessories

Hand Tube Benders

© HTB Series



Tube Cutters

© FTC Series



Other Elements

© Thermowells and Bosses



Manual Presetting Tools

© MPT Series



Hydraulic Presetting Tools

© HPT Series



© Syphons



Tube Deburring Tools

© TDT Series



Bulkhead Retainers

© BR Series



© Flush Rings



Gap Inspection Gauges

© GIG Series



Individual size



Multiple sizes

© Gaskets and O-rings



Medium & High Pressure Applications

15D Series Tube Fittings 10,000 - 15,000 psig



PMH Series Pipe Fittings 10,000 - 60,000 psig

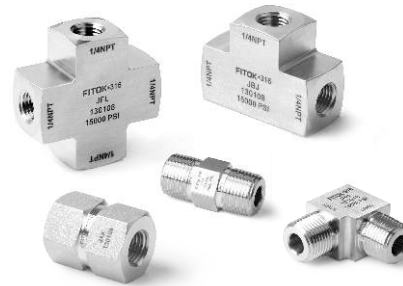

20 Series Medium Pressure Fittings 20,000 psig



AMH Series Adapter Fittings 10,000 - 60,000 psig



60 Series High Pressure Fittings 60,000 psig



Quick Couplings 10,000 - 30,000 psig

© HQP, HQB, HQS and HQC Series



Ball Valves 10,000 - 20,000 psig

© 10B, 15B and 20B Series



Pneumatic Ball Valves 10,000 - 20,000 psig

© AO, AC and AOC Types



Needle Valves

10,000 - 60,000 psig

© 10N, 15N, 20N, 30N and 60N Series



Pneumatic Needle Valves

10,000 - 60,000 psig

© ATO and ATC Types



Check Valves

10,000 - 60,000 psig

© 10C, 15C, 20C and 60C Series

© 10CO, 15CO, 20CO and 60CO Series



Metering Valves

15,000 - 60,000 psig

© 15M, 30M and 60M Series



Relief Valves

20,000 - 60,000 psig

© HSR, HMR and HAR Series



Bleed Valves and Block & Bleed Valves

15,000 - 30,000 psig

© 15BV, 20BV and 30BV Series

© 15BN, 20BN, 20DBN and 15DBB Series



Medium & High Pressure Applications

Excess Flow Valves

15,000 - 60,000 psig

- ◎ 15EF, 20EF and 60EF Series



Line Filters

10,000 - 60,000 psig

- ◎ 10FD, 15FD, 20FD and 60FD Series
- ◎ 10FC, 15FC, 20FC and 60FC Series



Tubing

10,000 - 60,000 psig



Subsea Valves

10,000 - 20,000 psig

- ◎ Subsea Ball Valves, Subsea Check Valves, Subsea Needle Valves and Subsea Hydraulic Directional Control Valves



Tools

- ◎ Coning Tools



- ◎ Manual Presetting Tools



- ◎ Threading Tools



- ◎ Hydraulic Presetting Tools



- ◎ Reseating Tools



Weld Fittings

- ◎ M Series Micro Weld Fittings



- ◎ L Series Tube Butt Weld Fittings



- ◎ A Series Automatic Tube Butt Weld Fittings



- ◎ T Series Tubular Fittings



Cylinder Connections

- ◎ CGA DISS, CGA and DIN Series



Face Seal Fittings

- ◎ FR Series Metal Gasket Face Seal Fittings



- ◎ FO Series O-ring Face Seal Fittings



- ◎ TFO Series L-ring Face Seal Fittings



Diaphragm Valves

○ DQ, DP, DH, DM, DS, DR, DV, DL and DF Series

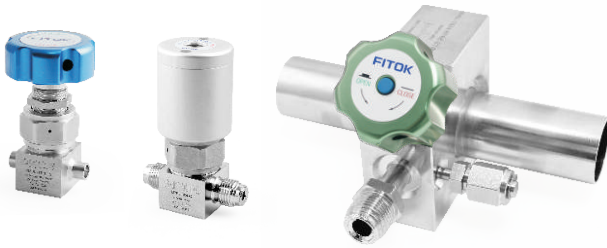

Bellows-sealed Valves

○ SM and SVH Series



Cylinder Pressure Regulators

○ FCR-1, FCR-1S, FCR-2 and FCR-1D Series



Check Valves

○ CW Series



Regulators

○ FHR-1 Series



Back Pressure Regulators

○ BPR-1, BPR-2 and BPR-3 Series



Line Pressure Regulators

○ FLR-1, FLR-2, FLR-3, FBR-1, HPR-10 and HPL-06 Series



Pressure Control Panels

○ FSR-1 and FSR-2 Series



Changeover Systems

○ FDR-1, FDR-2, FDR-1L and FDR-1T Series



Point-of-use Panels

○ FPR-1 and FPR-1S Series



Bottle Configuration Sampling Systems

- © **BLA2 - System Purge Type**
Sampling from low pressure devices or process lines



- © **BLD2 - Continuous Needle Purge Type**
Sampling from medium or high pressure devices or process lines



- © **BLE3 - Back Purge Type with Venturi Unit**
Sampling from process lines at atmospheric pressure or vacuum condition



Cylinder Configuration Sampling Systems

- © **CSF4 - Outlet to Flare Type with Expansion Chamber**
For liquefied gas sampling



- © **CGG1 - System Purge Type**
For gas sampling



Instrumentation Tubing

○ **TMP Series**

Straight-length tubing
2.6%Mo tubing optional

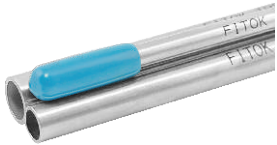

○ **TCT Series**

Supplied up to 2130 ft (650 m) in coils



Medium and High Pressure Tubing

○ **T15 Series**

Pressure up to 15,000 psig



○ **T20 Series**

Pressure up to 20,000 psig



○ **T60 Series**

Pressure up to 60,000 psig



High Purity Tubing

○ **TBA and TEP Series**

TBA series: inner surface roughness
 $Ra \leq 20 \mu\text{in.}$ (0.51 μm), for high purity
gas systems;

TEP series: inner surface roughness
 $Ra \leq 10 \mu\text{in.}$ (0.25 μm), for ultra high
purity systems;



Jacketed Tubing and Insulated Tubing

○ **TJT and TIT Series**

TJT series: PVC jacketed tubing

TIT series: fibrous glass insulated tubing



Heat Trace Tubing

○ **TST Series**

Steam trace



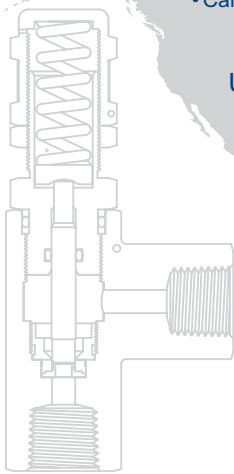
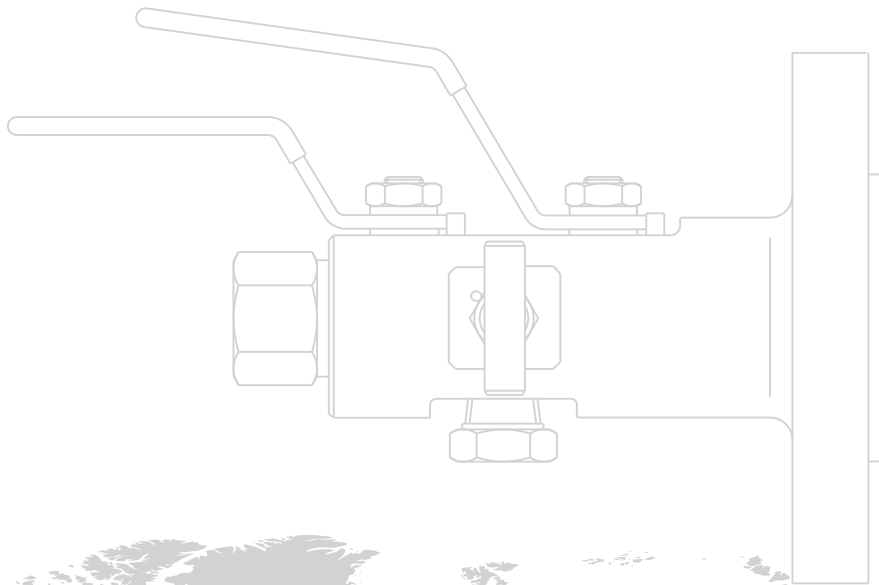

FITOK Group

FITOK GmbH (Headquarters)

Sprendlinger Landstr. 115, 63069 Offenbach am Main, Germany
 Tel.: +49 69 8900 4498 Fax: +49 69 8900 4495

FITOK, Inc.

13843 North Promenade Blvd., Suite 750, Stafford, Texas 77477, USA
 Tel.: +1 281 888 0077 Fax: +1 281 582 4051

FITOK Incorporated

1-4F, Block C, Zone E, Yingtai Industrial Park, Dalang Street,
 Longhua District, Shenzhen, 518109, China
 Tel.: +86 755 2803 2500 Fax: +86 755 2803 2619

FITOK (Suzhou) Metal Products Co., Ltd.

No. 29 Changsheng Road, Yangyuan Industrial Park, Xinzhuang Town,
 Changshu, Jiangsu 215562, China
 Tel.: +86 512 5247 9001 Fax: +86 512 5247 9002

FITOK Middle East Oil Equipment Trading LLC

Makateb Building, P.O.Box 185412, Airport Road, Deira, Dubai, UAE
 Tel.: +971 4 2959 853 Fax: +971 4 2959 854

FITOK Canada Inc.

5407 Roper Rd. Edmonton, Alberta, T6B 3L6, Canada
 Tel.: +1 780 966 8895

info@fitokgroup.com
 www.fitokgroup.com

